

# The **SCRIBBLER** **ROBOT** Start-up Guide

Ages 8 +

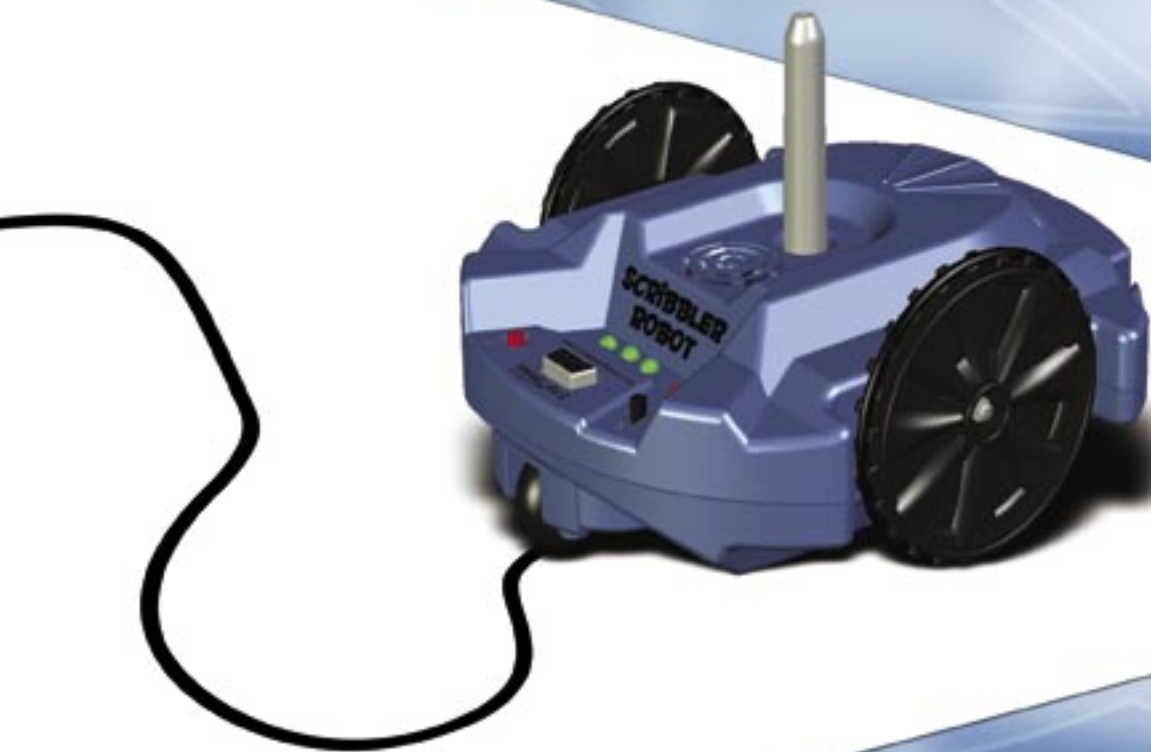

**PARALLAX**

[www.parallax.com](http://www.parallax.com)

[www.ScribblerRobot.com](http://www.ScribblerRobot.com)

## Scribbler Robot (part # 28136) For Ages 8+

Please read and retain this instruction booklet.

Do not open the Scribbler Robot case, except the battery compartment. Contains no user-maintainable parts. **Opening case voids warranty.**

Conforms to the requirements of ASTM F963-03 Standard Consumer Safety Specification on Toy Safety. Distributed by Parallax Inc., 599 Menlo Drive, Suite 100, Rocklin CA 95765 USA

### Battery Safety

- Only adults should install and replace batteries.
- Do not recharge non-rechargeable batteries.
- Remove dead or exhausted batteries from Scribbler.
- Insert batteries correctly; match positive and negative signs.
- Do not place anything across the battery terminals.
- Use only the size and type of batteries specified in this booklet.
- Do not mix different types of batteries.
- Do not mix old and new batteries.
- Dispose of batteries safely.
- Do not dispose batteries in a fire, they may explode.
- The supply terminals are not to be short-circuited.



### **WARNING: CHOKING HAZARD**

Contains Small Parts. Not for children under 3 years.



### **CAUTION: SHARP POINTS AND EDGES**

Functional sharp points and edges on serial cable.



### **CAUTION: HAIR ENTANGLEMENT HAZARD**

Keep hair from coming in contact with moving wheels of robot.

This device complies with Part 15 of the FCC rules. Operation is subject to the following two conditions: (1) this device may not cause harmful interference, and (2) this device must accept any interference received, including interference that may cause undesired operation.

**Warning:** Changes or modifications to this unit not expressly approved by the party responsible for compliance could void the user's authority to operate the equipment.

## WARRANTY

Parallax Inc. warrants its products against defects in materials and workmanship for a period of 90 days from receipt of product. If you discover a defect, Parallax Inc. will, at its option, repair or replace the merchandise. **For assistance contact Parallax:** call (916) 624-8333, or toll free in the USA or Canada 888-512-1024, or email [support@parallax.com](mailto:support@parallax.com).

BASIC Stamp, Boe-Bot, SumoBot and Toddler are registered trademarks of Parallax Inc. Parallax, the Parallax logo, and Scribbler are trademarks of Parallax Inc. Sharpie is a registered trademark of Sanford, L.P. © 2005 Parallax Inc. All Rights Reserved. Rev 1.0.

# Package Contents

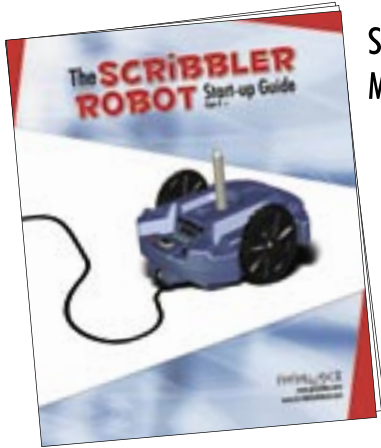

Scribbler  
Manual

Scribbler™ Robot



Software on  
CD-ROM



Serial Programming Cable

## Additional Items Needed (not included in kit)

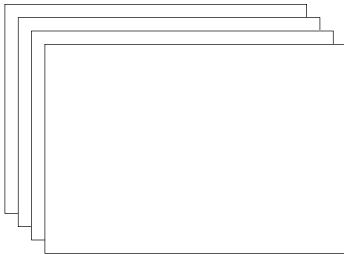

White poster board

Markers - up to ½ inch  
(12 mm) diameter, such  
as a Sharpie® fine point.



6 (six) "AA" batteries. You may use 1.5V alkaline, 1.5V standard (carbon-zinc) or 1.2V rechargeable NiMH (nickel-metal-hydride) batteries.



### CAUTION:

- Do not mix different types of batteries.
- Do not mix old batteries with new batteries.
- Do not store the Scribbler with batteries installed.

# Top View

infrared emitters

infrared detector

light sensors

pen port

speaker

indicator LED lights  
(LED = Light Emitting Diode)

power switch

power light

programming port (for serial cable)

reset button

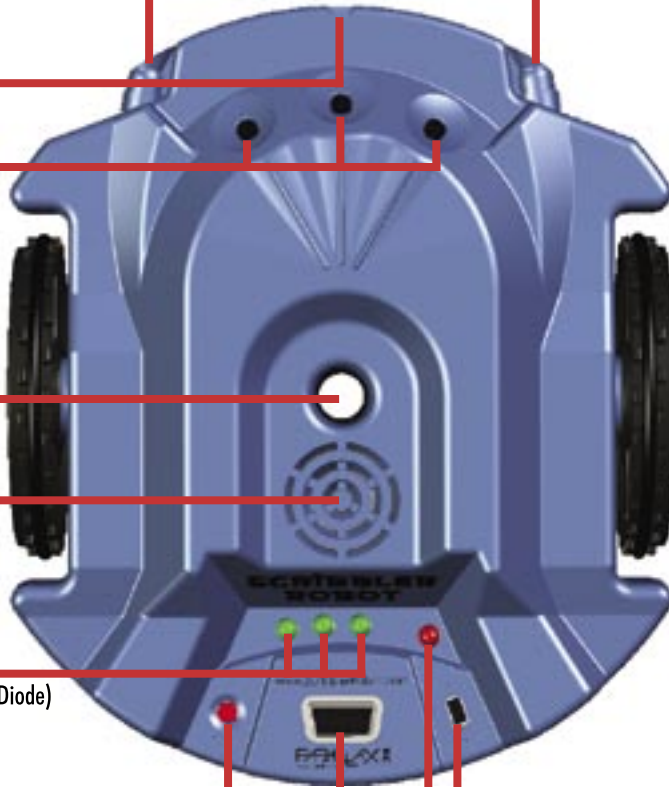

# Bottom View

---

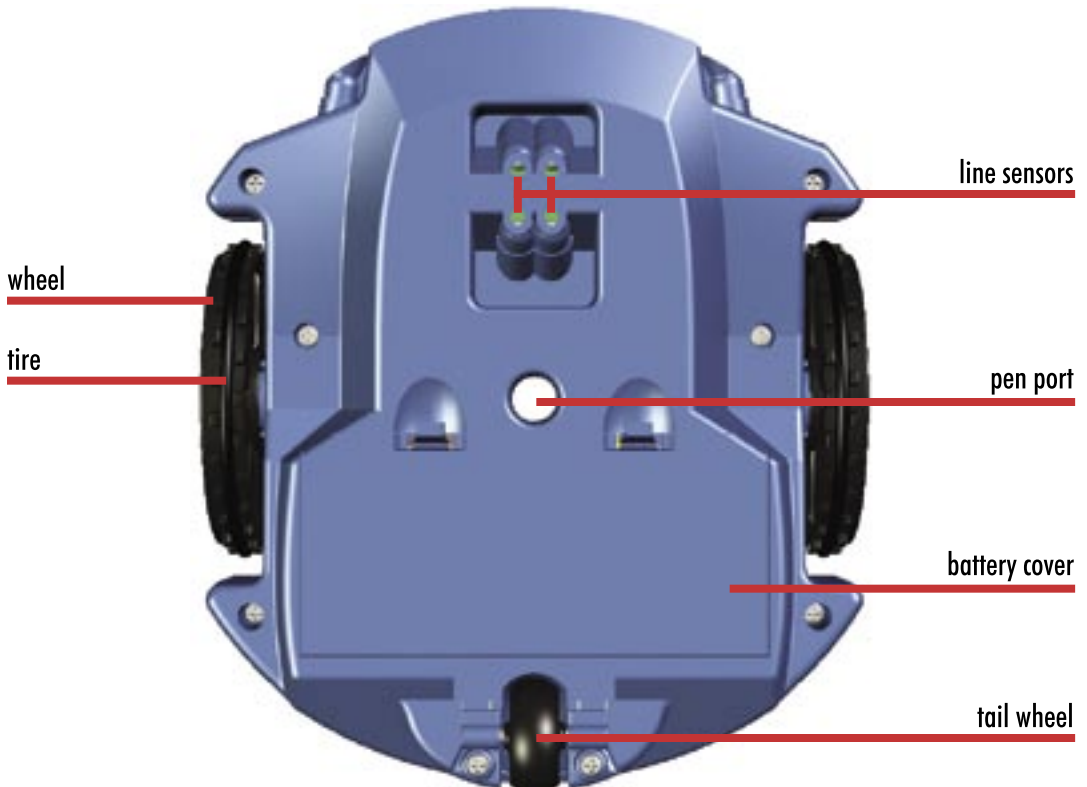

# Battery Installation



You need 6 (six) "AA" batteries.

You may use 1.5V alkaline, 1.5V standard (carbon-zinc) or 1.2V rechargeable NiMH (nickel-metal-hydride) type batteries.



## CAUTION:

- Do not mix different types of batteries.
- Do not mix old batteries with new batteries.
- Do not store the Scribbler with batteries installed.



Put the power switch in the "OFF" position.

"I" = On

"O" = Off



Place the Scribbler face down. Remove the battery cover by pulling the cover latches down toward the tail wheel and then lift the battery cover up.

battery cover latches

Step  
4

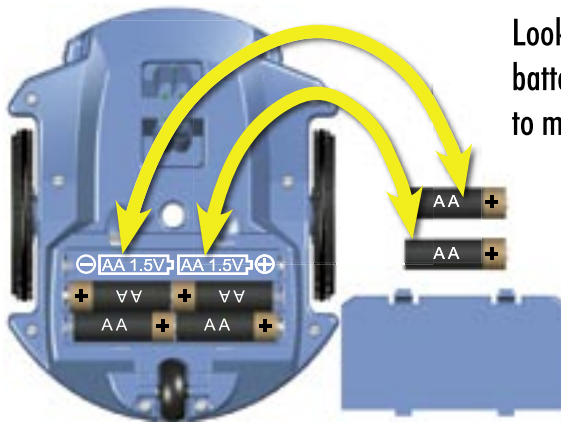

Look for polarity symbols (+/-) in battery compartment. Insert batteries to match up with polarity symbols.

Step  
5

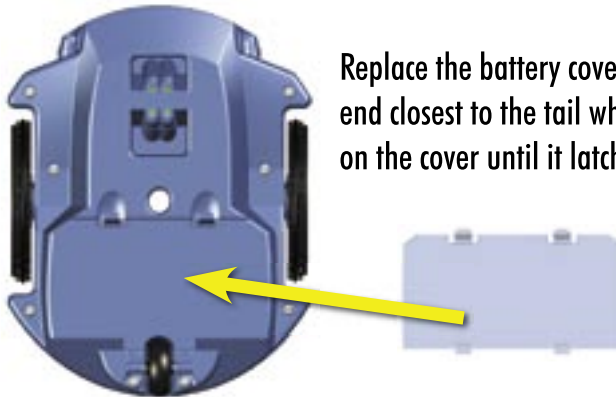

Replace the battery cover by inserting the tabs on the end closest to the tail wheel first and then pressing on the cover until it latches into place.

**STOP!**

Do not operate Scribbler with battery cover removed.

**extra**  
\*

When the Scribbler detects low battery voltages, it will slowly start blinking the red power light.

# Demo Ø: Light Sensors

light sensors

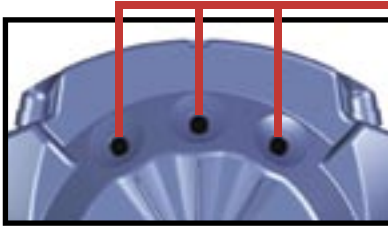

The Scribbler has 3 light sensors. If you place your finger on a light sensor, the Scribbler can “see” it because you have blocked out the light shining on the sensor.

Step  
1

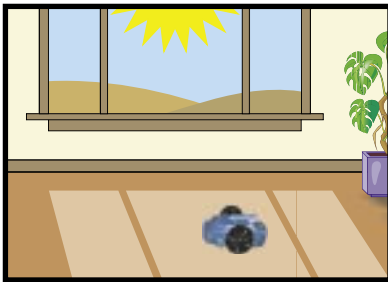

Place your Scribbler on the floor in a brightly lit room.

Step  
2



Put the power switch in the “ON” position.



You will hear a song, and all 3 green LEDs will light up.



Step  
3

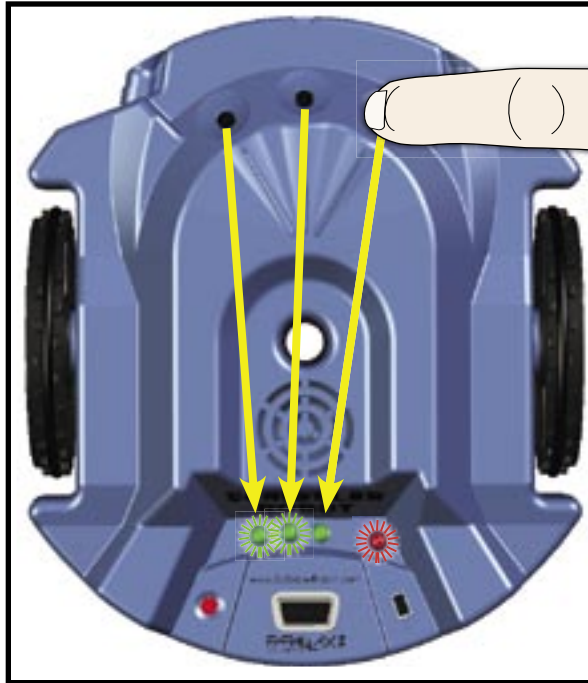

Cover a light sensor hole with your finger. A green LED will turn off.

In this demo mode, the left light sensor controls the left green LED, the center light sensor controls the center green LED, and the right light sensor controls the right green LED. Other Demos will use the green indicator LEDs in a different way.



Your Scribbler must have the power switch in the "ON" position to run the Demo programs.

There are 8 Demo play modes. You will use the light sensors to select the Demo play mode that you want. You always need to be in a brightly lit area to select Demo modes.

Demo 0 is selected each time you turn on the Scribbler, if all the light sensors are uncovered. You can also choose Demo 0 by pressing the reset button with all the light sensors uncovered.

# Demo 1: Light Seeking Behavior

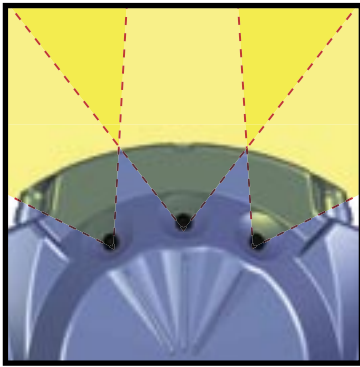

The three light sensors can detect bright light in front of the Scribbler. One sensor looks straight ahead, the other two look 30° to the right and left.

Step  
1

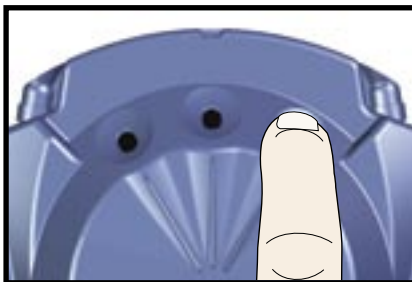

+

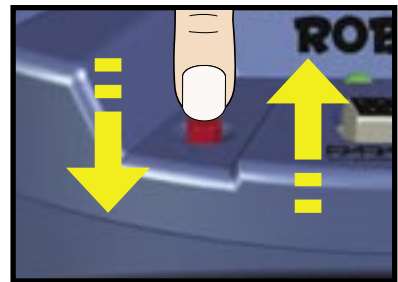

While you cover the right light sensor, press and release the reset button.

Step  
2

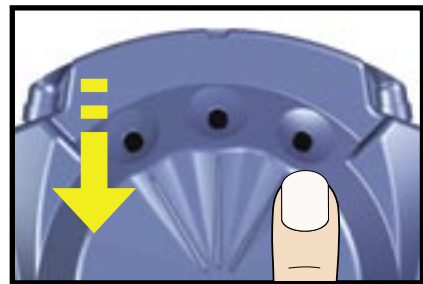
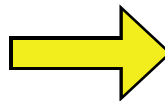

Listen for the beep, then uncover the light sensor.

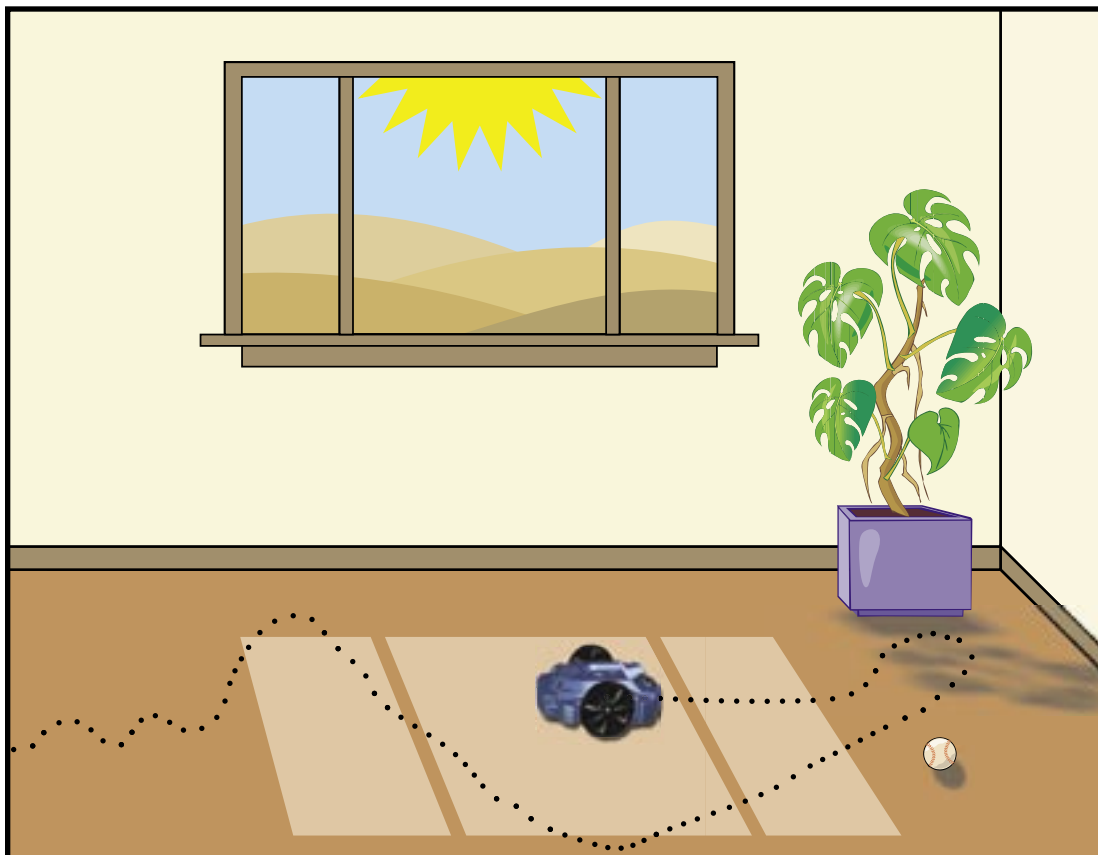

The Scribbler plays a long note, then drives around the room seeking the brightest light within its view.

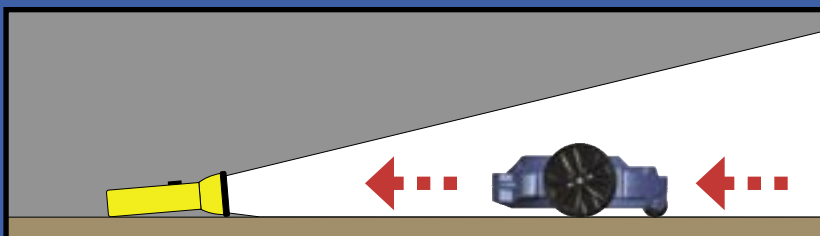

**Try this:** In a dark room, hold a flashlight at floor level facing the Scribbler. As you move the flashlight around the floor, the Scribbler will follow it!

# Demo 2: Object Detection

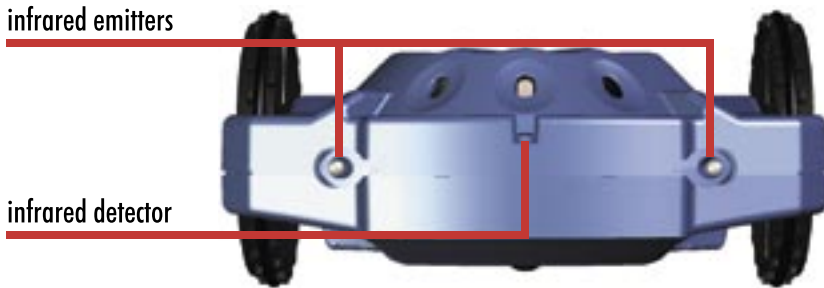

Infrared light shines from the emitters, even though your eyes cannot see it. The Scribbler can detect the light after it reflects off an obstacle and bounces back to its infrared detector "eye".

Step  
1

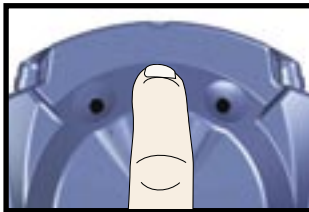

+

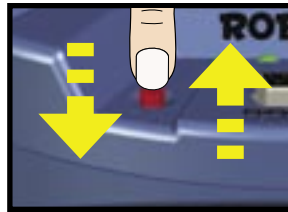

While covering the center light sensor, press and release the reset button.

Step  
2

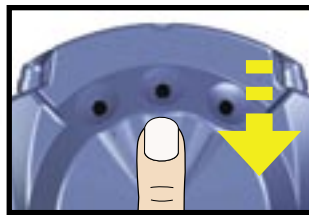

When you hear the beep, uncover the light sensor.

Step  
3

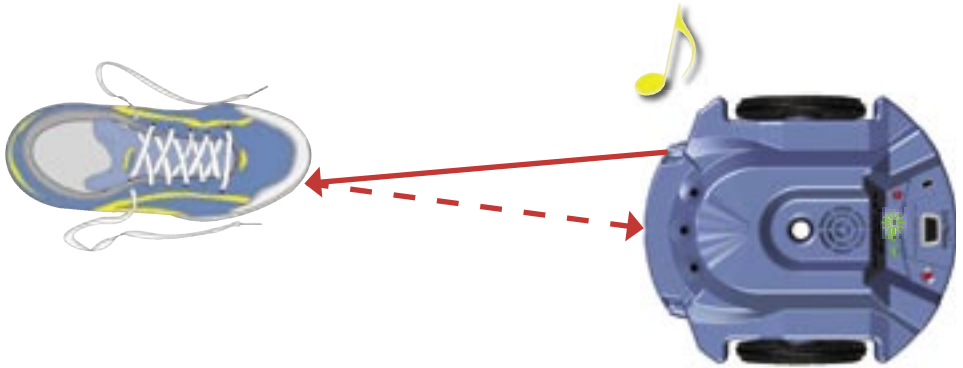

Place an object on the floor in front of the Scribbler. If the Scribbler sees the object on its right, the right green LED turns on, and the speaker plays a tone.

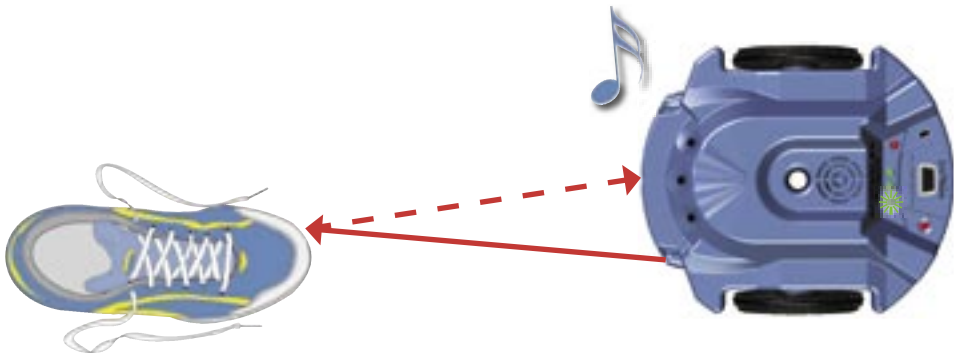

If the Scribbler sees an object on its left, the left green LED turns on and the speaker plays a different tone.



If the Scribbler can see the object with both sensors it will play both tones and both green LEDs will turn on.

The Scribbler can see light, shiny objects better than very dark and dull objects, because dark objects do not reflect much infrared light.

# Demo 3: Avoiding Objects Behavior

Step  
1

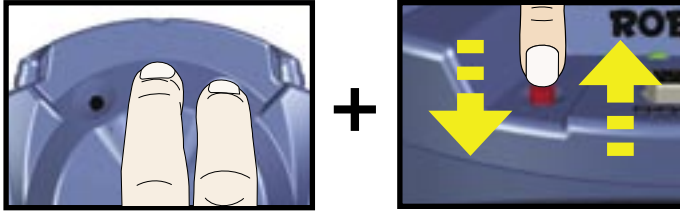

While holding your fingers on the center and right light sensors, press and release the reset button.

Step  
2

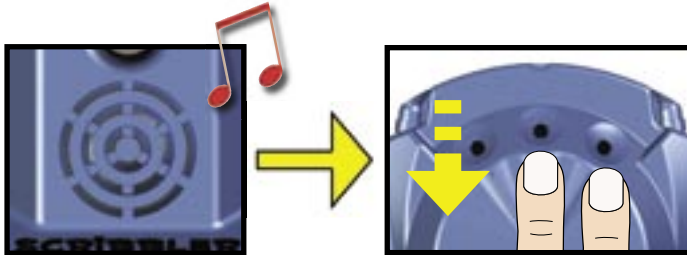

When you hear the beep, uncover the light sensors.

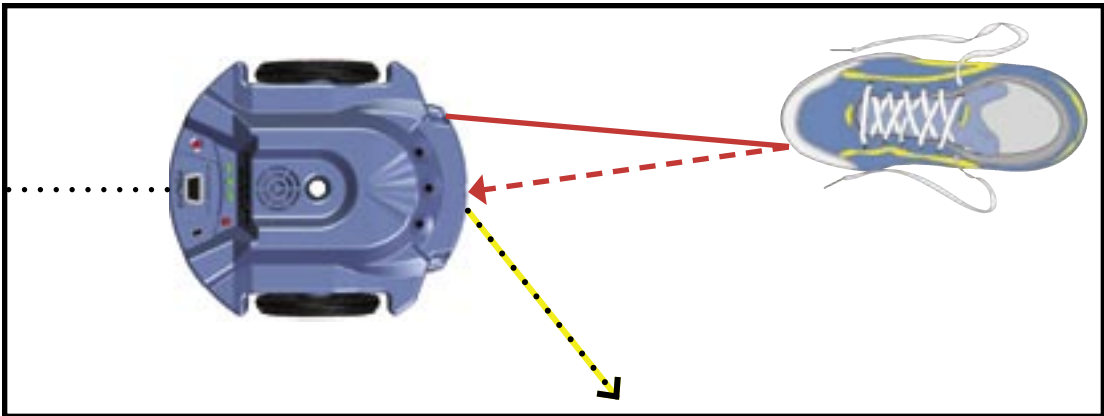

The Scribbler will drive around the room, turning to avoid objects.

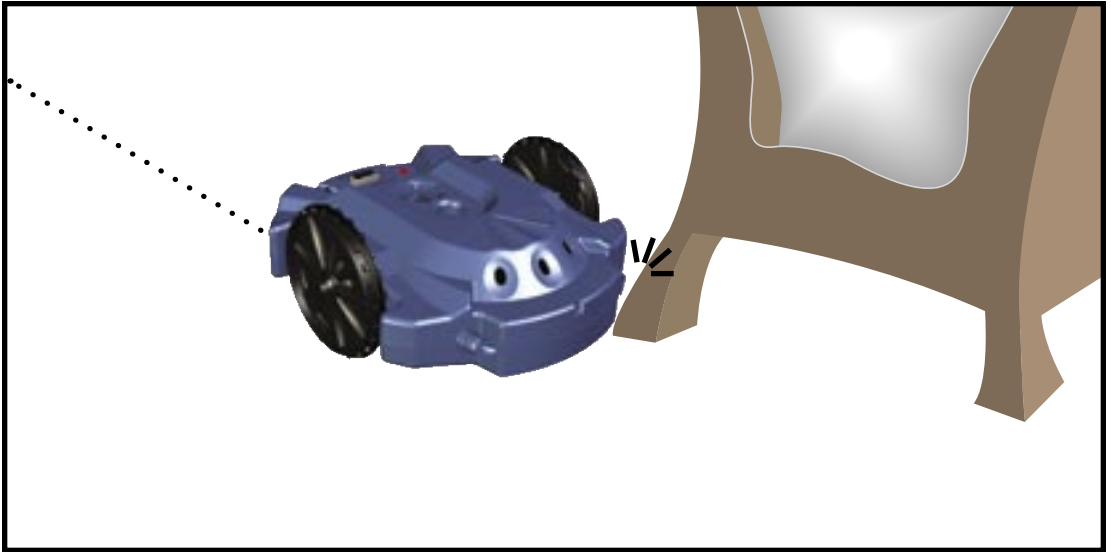

The Scribbler has a stall sensor inside. If it gets stalled on an object it cannot see...

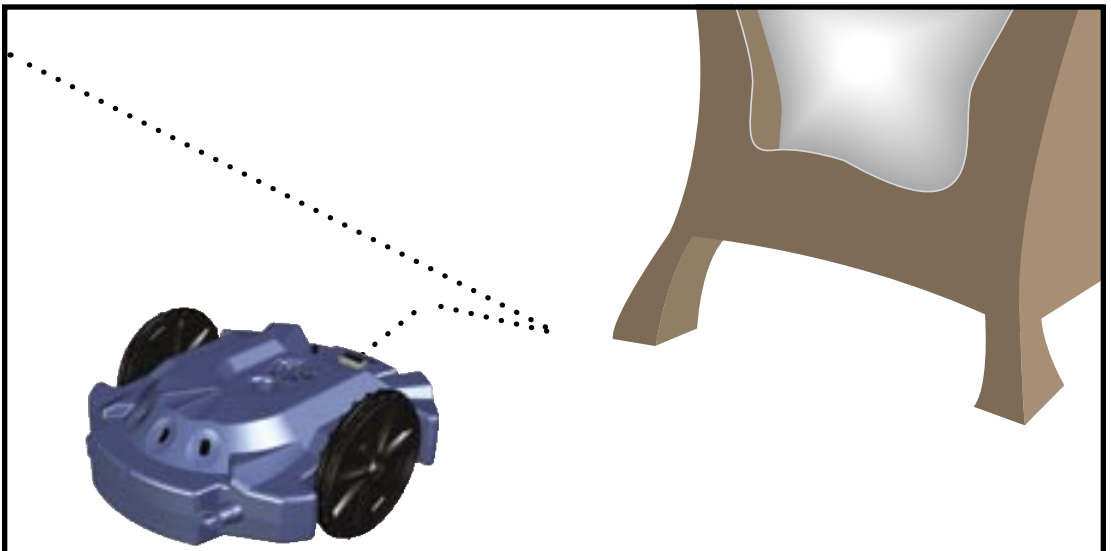

...it will back up, turn, and try driving forward again.

## Demo 4: Line Sensor



The scribbler has two pairs of infrared emitters and detectors on its underside. With them, it can see a black line on white paper.

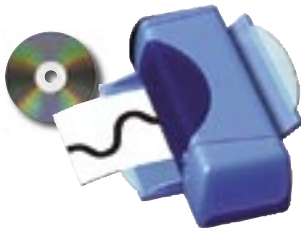

Print out a set of black lines from the Scribbler software CD (file name: Tracks.pdf). For a view of what the printed tracks look like, see page 18 of this booklet.



Draw your own tracks by making a black line  $\frac{3}{4}$  inch (2 cm) wide, on white paper. To do this you will need:

- white paper
- a black marker



Adult supervision recommended. Always protect surfaces with paper when using a marker or any other writing instrument with your Scribbler. Be aware that some markers can bleed through paper and stain the surface beneath, so test first.



Step  
2



While holding your finger on the left light sensor, press and release the reset button.

Step  
3

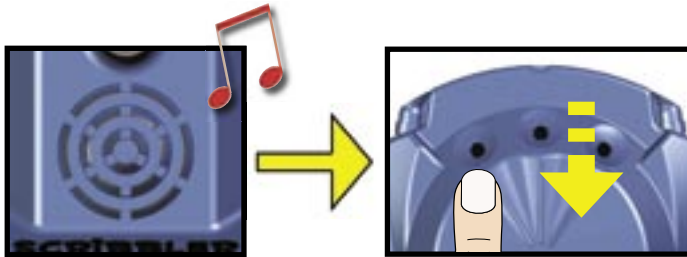

When you hear the beep, uncover the light sensor.

Step  
4



Place the Scribbler on the paper, and move it back and forth across the black line. If the right sensor sees the line, the right green LED will light up. If the left sensor sees the line, the left green LED will light up. If both sensors see the line, both green LEDs light up.

**extra**  
\* The Scribbler must be resting on the paper to see the line.

# Demo 5: Line Following Behavior

Step  
1

Make black lines on white paper as a track for the Scribbler to follow.



Print out a set of black lines from the Scribbler Software CD (file name: Tracks.pdf).

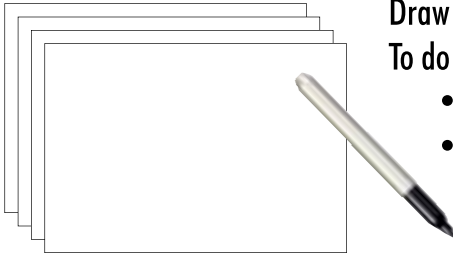

Draw your own lines,  $\frac{3}{4}$  inch (2 cm) wide.

To do this you will need:

- white paper
- a black marker



Adult supervision recommended. Be aware that some markers can bleed through paper and stain the surface beneath, so test first.

Step  
2

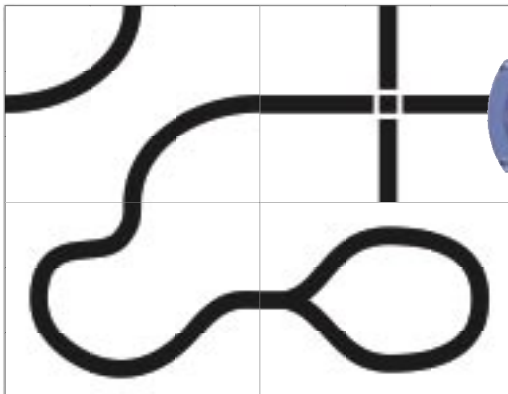

Place the track on a hard floor, and then place the Scribbler on the track.

Step  
3



While holding your fingers on the left and right light sensors, press and release the reset button.

Step  
4

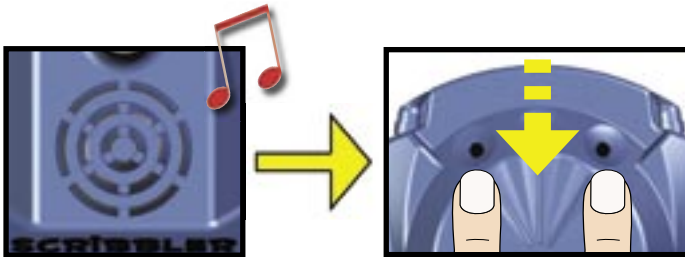

Listen for the beep, then uncover the light sensor.

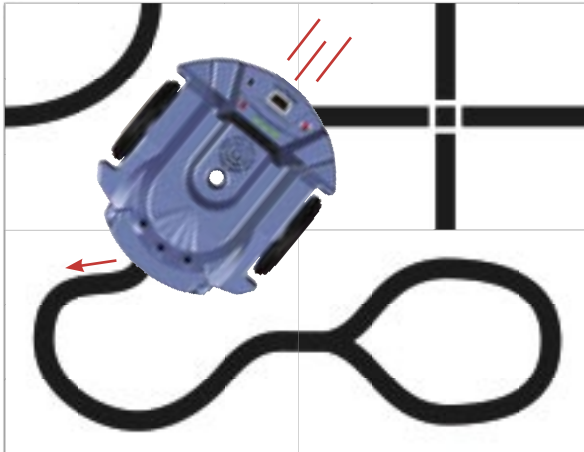

The Scribbler turns from side to side to find the line, then starts following it. If the Scribbler loses the line on a tight corner, it will turn back and forth to look for it again.



The Scribbler does best following black lines about  $\frac{3}{4}$  inch (2cm) wide, on a white background. Line following works best when the track is placed on a hard, level surface. Carpet, tile, or other uneven surfaces may not work well. A dark surface may show through thin paper and make the line harder for the Scribbler to see.

# Demo 6: Scribble Behavior

Step  
1

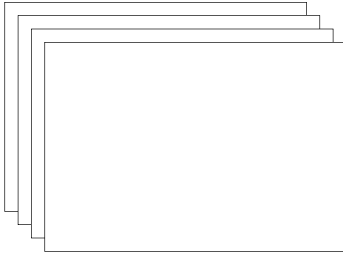

Find:

- white paper or poster board
- a marker

Step  
2



Place paper on the floor, and then place Scribbler on the paper.

Step  
3



Place a marker in the pen port. The tip of marker must touch the paper.

**ALERT**

Always protect surfaces with paper or poster board when using a marker or any other writing instrument in your Scribbler. Be aware that some markers can bleed through paper and stain the surface beneath, so test first.

Step  
4



While covering the left and center light sensors, press and release the reset button.

Step  
5

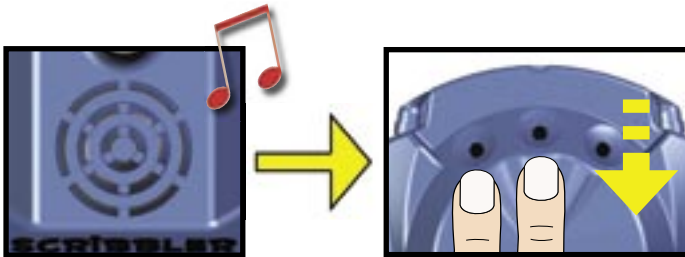

Listen for the beep, then uncover the light sensors.

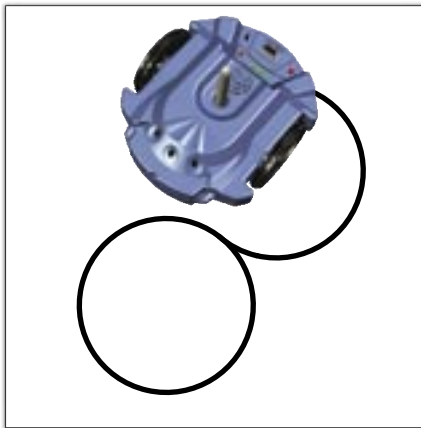

The Scribbler will draw an approximate figure 8 and then beep.

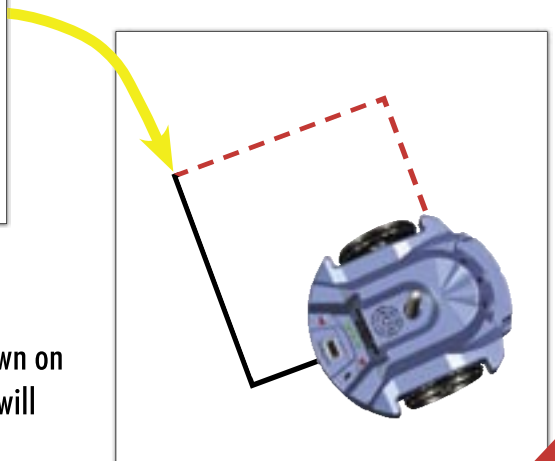

Step  
6

Pick up the Scribbler and put it down on another part of the paper. Then it will draw a box.

# Demo 7: Ambulance Behavior

Step  
1

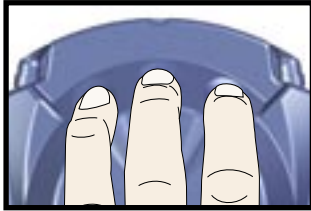

+

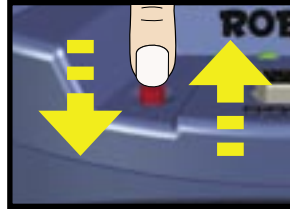

While you cover all 3 light sensors, press and release the reset button.

Step  
2

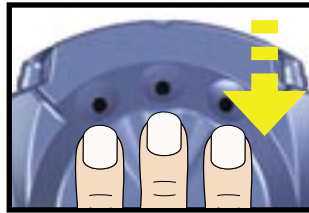
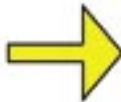

Listen for the beep, then uncover the light sensors.

The Scribbler drives around blaring its siren and flashing its lights, while avoiding walls and obstacles.

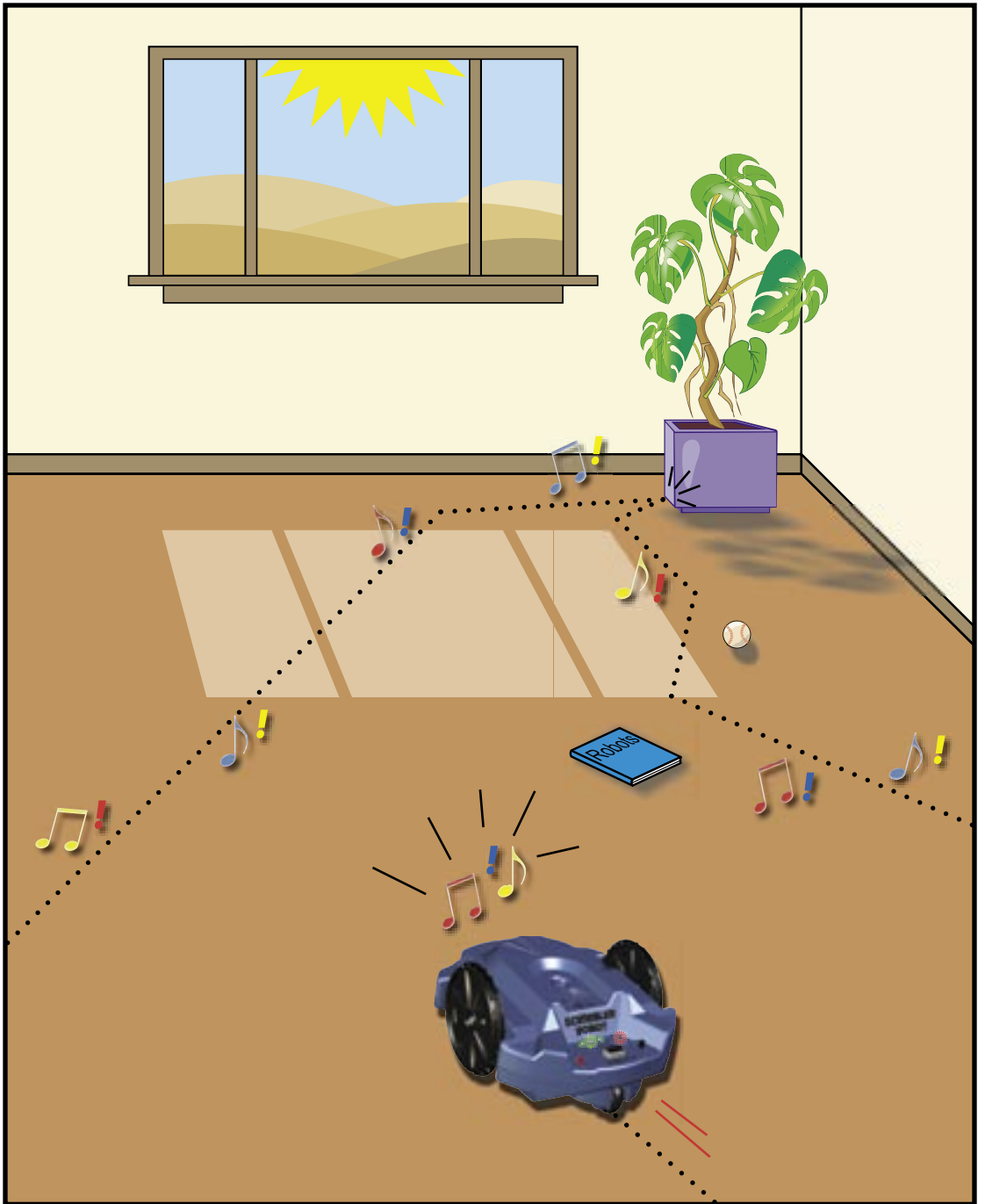

# Programming your Scribbler Robot

Your Scribbler robot contains a reprogrammable “brain”, the BASIC Stamp® 2 microcontroller. This BASIC Stamp module comes pre-programmed with the 8 Demo modes shown in this guide. You can also write your own custom programs on your PC, and download them to your Scribbler robot through the provided serial cable.

Beginners can program in picture blocks with the Scribbler GUI (Graphical User Interface) programming software. Those familiar with text-based programming can use the BASIC Stamp Editor to write programs in PBASIC.

Adult supervision is recommended for software installation and hardware connections.



- 1) Connect the serial cable to an available serial port on your computer.
- 2) Connect the other end of the serial cable to the Scribbler programming port.
- 3) Insert the Scribbler Software CD into the computer's CD drive or go to the **www.ScribblerRobot.com** website.
- 4) Follow the links and instructions that appear on the screen to install the desired software.

## Computer system requirements:

- PC running Windows® 2000/XP
- CD-ROM Drive
- Available serial port **-or-** Available USB port with the FTDI USB-to-serial adapter (Parallax part #800 00030)
- Printer to print out your tracks for the Scribbler to follow



# The Scribbler GUI – for Beginners Age 8+

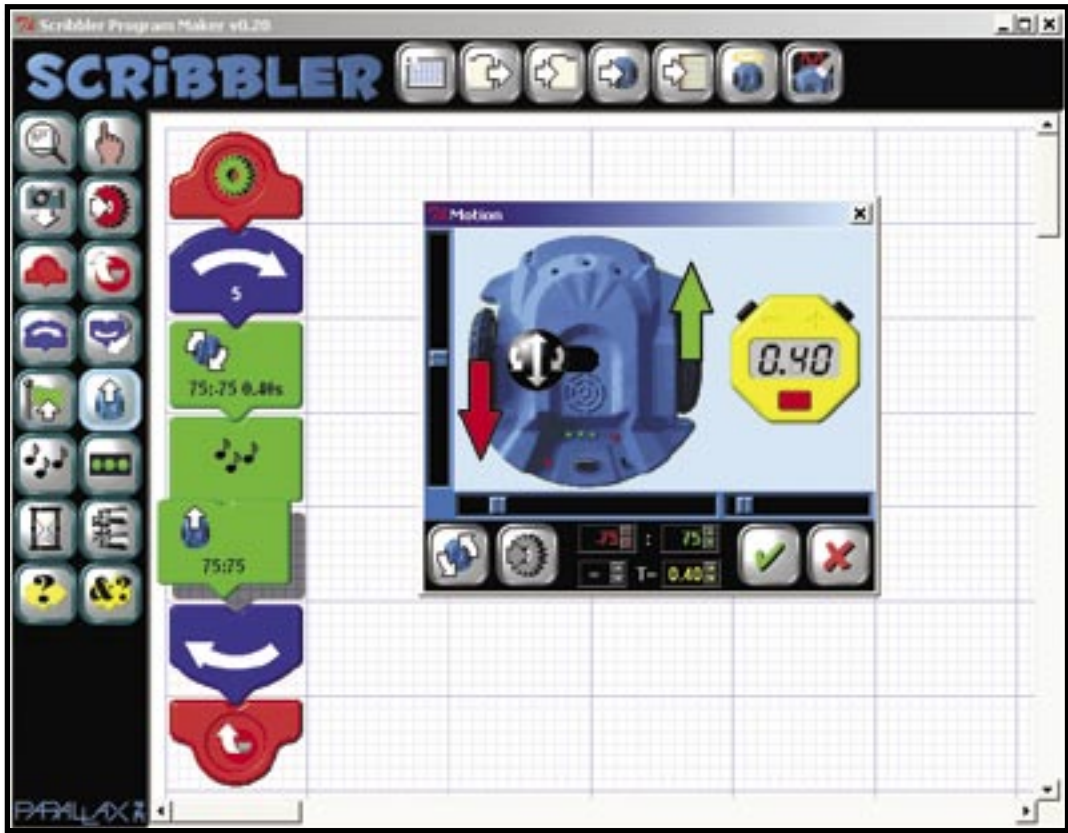

Look for the very newest version of the Scribbler GUI software on our website [www.ScribblerRobot.com](http://www.ScribblerRobot.com). Here you can download the free Scribbler GUI Programming Guide, and many example programs that demonstrate the very latest features.

The Scribbler GUI software lets you build your own programs with picture-coded action “blocks” that turn wheels, blink lights, play sounds, and more. Arrange them in the sequence you want, download the program, and your Scribbler robot will perform your routine. When you are done, you can press the Restore button on the tool bar to reload the original Scribbler Demo program.

# The BASIC Stamp Editor – For Advanced Users age 14+

Advanced users who want direct control of the Scribbler's motors, sensor systems, speaker, and lights have the option of writing programs in PBASIC with the BASIC Stamp Editor. This text editor is used by students, educators, scientists, and engineers to program the BASIC Stamp microcontrollers in their own inventions.

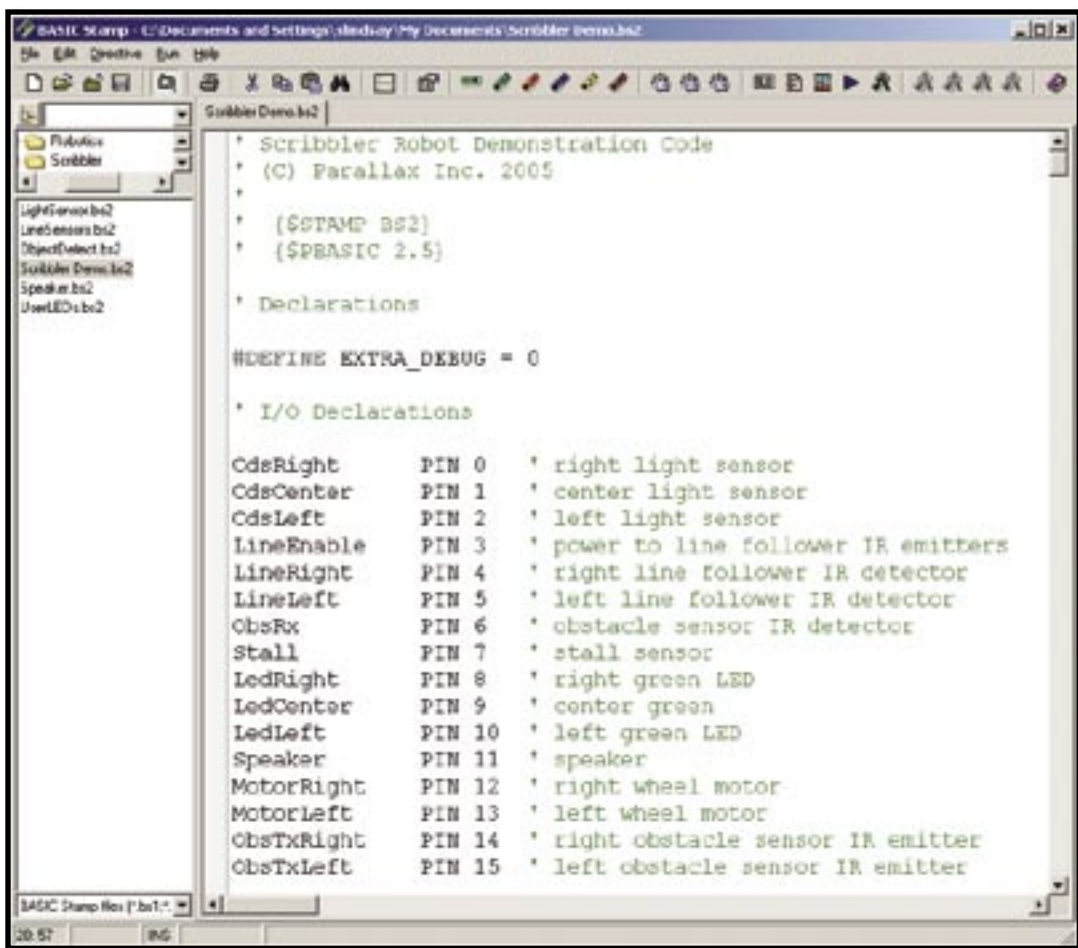

The screenshot shows the BASIC Stamp Editor window titled "BASIC Stamp - [C:\Documents and Settings\jbeddy\My Documents\Scribbler Demo.bs2]". The window contains a menu bar (File, Edit, DevTools, Run, Help), a toolbar, and a file explorer on the left showing a folder named "Scribbler" with files like "LightSensor.bs2", "LineSensors.bs2", "ObjectDetect.bs2", "Scribbler Demo.bs2", "Speaker.bs2", and "UserLEDs.bs2". The main text area displays the following code:

```
* Scribbler Robot Demonstration Code
* (C) Parallax Inc. 2005
*
* {$STAMP BS2}
* {$PBASIC 2.5}

* Declarations

#DEFINE EXTRA_DEBUG = 0

* I/O Declarations

CdsRight      PIN 0   * right light sensor
CdsCenter     PIN 1   * center light sensor
CdsLeft       PIN 2   * left light sensor
LineEnable    PIN 3   * power to line follower IR emitters
LineRight     PIN 4   * right line follower IR detector
LineLeft      PIN 5   * left line follower IR detector
ObsRx         PIN 6   * obstacle sensor IR detector
Stall         PIN 7   * stall sensor
LedRight      PIN 8   * right green LED
LedCenter     PIN 9   * center green
LedLeft       PIN 10  * left green LED
Speaker       PIN 11  * speaker
MotorRight    PIN 12  * right wheel motor
MotorLeft     PIN 13  * left wheel motor
ObsTxRight    PIN 14  * right obstacle sensor IR emitter
ObsTxLeft     PIN 15  * left obstacle sensor IR emitter
```

# Resources for BASIC Stamp Programming

The Scribbler PBASIC Programming Guide gives you an introduction to BASIC Stamp programming geared toward writing PBASIC programs specifically for your Scribbler robot.

It lists the connections between the BASIC Stamp module's input/output pins and the Scribbler robot's electronic components. Example programs demonstrate how to directly control each of these systems:

- Three user-accessible LEDs
- Photoresistor light sensors
- Infrared line sensor system
- Stall sensor
- Speaker
- Infrared object detectors
- DC drive motors

Download the free Scribbler PBASIC Programming Guide and all the example source code from [www.ScribblerRobot.com](http://www.ScribblerRobot.com).

The microcontroller in your Scribbler robot is a BASIC Stamp 2 OEM. The BASIC Stamp Syntax and Reference Manual is a complete resource for all models of BASIC Stamp microcontrollers. It includes a guide to the BASIC Stamp Editor software, in-depth architecture and syntax information, and example programs for each PBASIC command.

The BASIC Stamp Manual is included on the Scribbler Software CD.

**NOTE:** This equipment has been tested and found to comply with the limits for a class B digital device, pursuant to Part 15 of the FCC Rules. These limits are designed to provide reasonable protection against harmful interference in a residential installation. This equipment generates, uses and can radiate radio frequency energy and, if not installed and used in accordance with the instructions, may cause harmful interference to radio communications.

However, there is no guarantee that interference will not occur in a particular installation. If this equipment does cause harmful interference to radio or television reception, which can be determined by turning the equipment off and on, the user is encouraged to try to correct the interference by one or more of the following measures:

- Reorient or relocate the receiving antenna.
- Increase the separation between the equipment and receiver.
- Connect the equipment into an outlet on a circuit different from that to which the receiver is connected.
- Consult the dealer or an experienced radio/TV technician for help.

# Have a question? Need Tech Support?

---

**Please contact Parallax directly for help!**

Our website: [www.ScribblerRobot.com](http://www.ScribblerRobot.com)

Our email: [support@parallax.com](mailto:support@parallax.com)

Toll free Tech Support in USA or Canada (888) 99-STAMP

Toll free Sales & Information in USA or Canada (888) 512-1024

Our phone number: (916) 624-8333

*Thank you for purchasing the Scribbler Robot!  
We want you to have the best possible robotics experience.*

---

***Learn about the whole family of  
Parallax Robots at [www.parallax.com](http://www.parallax.com)***



**Boe-Bot® Robot**  
#28132



**SumoBot® Robot**  
#27400



**Toddler® Robot**  
#27311

---